

正式图 参考图 设变图

REV.	ECN NO.	DESCRIPTION	DATE	DESIGN
AO	---	INITIAL RELEASED	2017.03.08	HAN MIN

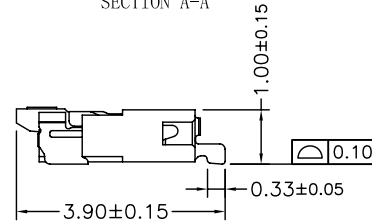

Applicable FFC

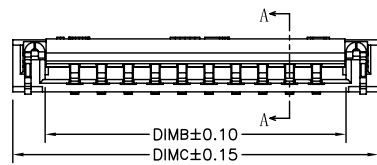
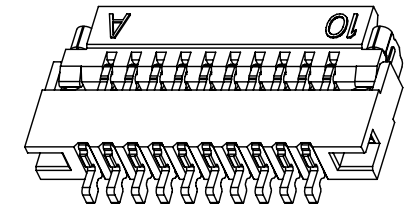
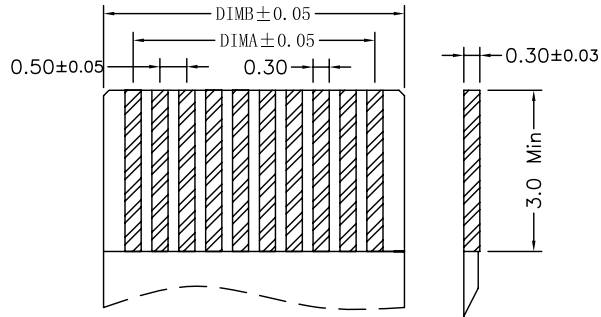
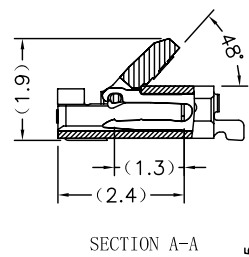
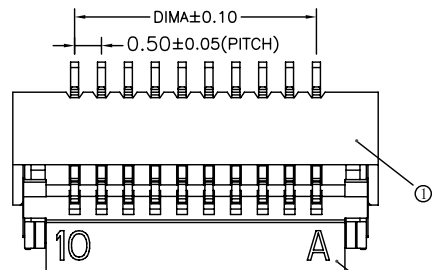
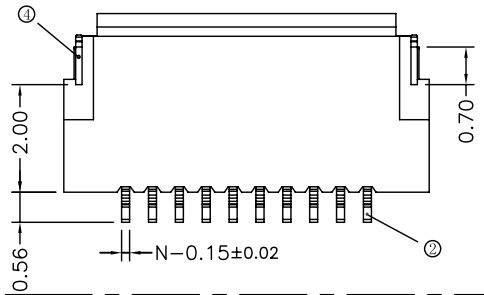

NOTE:  
 1.Current Rating: 0.5A  
 2.Rated voltage:50V AC\DC  
 3.Dielectric Withstanding Voltage:  
 AC250V/1minute  
 4.Contact resistance: ≤30mΩ Max  
 5.Insulation resistance: ≥500MΩ  
 6.Temperature range:  
 -25°C to +85°C

PIN	DIMA	DIMB	DIMC	PIN	DIMA	DIMB	DIMC
4	1.50	2.60	3.80	28	13.50	14.60	15.80
5	2.00	3.10	4.30	29	14.00	15.10	16.30
6	2.50	3.60	4.80	30	14.50	15.60	16.80
7	3.00	4.10	5.30	31	15.00	16.10	17.30
8	3.50	4.60	5.80	32	15.50	16.60	17.80
9	4.00	5.10	6.30	33	16.00	17.10	18.30
10	4.50	5.60	6.80	34	16.50	17.60	18.80
11	5.00	6.10	7.30	35	17.00	18.10	19.30
12	5.50	6.60	7.80	36	17.50	18.60	19.80
13	6.00	7.10	8.30	37	18.00	19.10	20.30
14	6.50	7.60	8.80	38	18.50	19.60	20.80
15	7.00	8.10	9.30	39	19.00	20.10	21.30
16	7.50	8.60	9.80	40	19.50	20.60	21.80
17	8.00	9.10	10.30	41	20.00	21.10	22.30
18	8.50	9.60	10.80	42	20.50	21.60	22.80
19	9.00	10.10	11.30	43	21.00	22.10	23.30
20	9.50	10.60	11.80	44	21.50	22.60	23.80
21	10.00	11.10	12.30	45	22.00	23.10	24.30
22	10.50	11.60	12.80	46	22.50	23.60	24.80
23	11.00	12.10	13.30	47	23.00	24.10	25.30
24	11.50	12.60	13.80	48	23.50	24.60	25.80
25	12.00	13.10	14.30	49	24.00	25.10	26.30
26	12.50	13.60	14.80	50	24.50	25.60	26.80
27	13.00	14.10	15.30				

See Ordering information:  
 FP0511W-XXP-SSXX-LP00X  
 (1) (2) (3)  
 (1):NO OF PIN :04P~50P  
 (2):Terminal plating:  
 AE=Gold(G/F) A5=Semi gold Tin  
 (3):Packing mode:  
 3=Tube 4=Tape & Reel

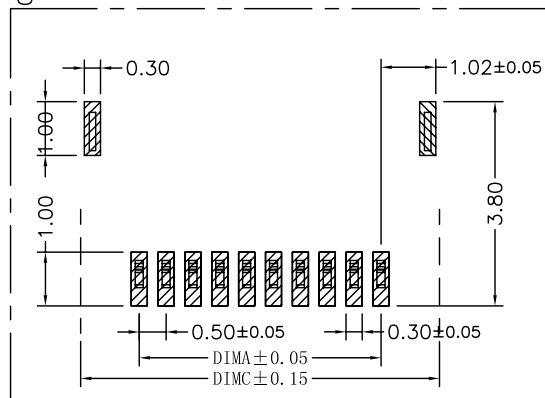

RECOMMENDED PCB Layout  
 DEFAULT TOLERANCES:±0.05(TOP VIEW)

TOLERANCE		NAME(INTENDED USE) CUSTOMER DRAWING	ZHAOBO 浙江朝博电子有限公司 Zhejiang Zhaobo Electronic Co.,Ltd		
X.X ±0.30	X.* ±10°	PART NO.	TITLE: 0.5 Pitch掀盖卧式(H=1.0)		
.XX ±0.20	.X.* ± 8°	See Ordering information	DRAWG NO. 03FP-0003		
.XXX ±0.10	.XX.* ± 5°	DESIGN: HAN MIN	SCALE SHEET REV. 1:1 1/1 AO		
UNITS mm		CHED: ZHU DE YIN	APPD: NI HAI QING		
MATERILA ----					
FINISH ----					

④	FITTING NAIL	2	Phosphor Bronze	Sn-plated
③	ACTUATOR	1	LCP UL94V-0	Black
②	TERMINAL	N	Phosphor Bronze	See Ordering information
①	HOUSING	1	LCP UL94V-0	Natural
NO.	PART NAME	QTY.	MATERIAL	REMARK